

33 500 882



- Saliente 137 mm
- Caño giratorio 360°
- Aireador redondo
- Altura máxima del conjunto 295 mm
- Altura hasta el aireador 187 mm
- Diámetro del orificio 35 mm
- 2x Latiguillo de presión M 8 x 1 enroscado, estanqueidad probada
- Caudal máx. 5,7 l/min
- Sin plomo
- Este producto puede ayudar a un edificio a cumplir con los requisitos de los sistemas de certificación ecológica de edificios: LEED®, BREEAM®, DGNB

Adecuado solo para lavabos con rebosadero.

	Cromo	33 500 882-00
	Platino cepillado	33 500 882-06
	Platino	33 500 882-08
	Dark Chrome	33 500 882-19
	Latón cepillado (Oro 23k)	33 500 882-28
	Negro mate	33 500 882-33
	Champagne cepillado (Oro 22k)	33 500 882-46
	Champagne (Oro 22k)	33 500 882-47
	Cromo cepillado	33 500 882-93
	Dark Platinum cepillado	33 500 882-99

33 500 882



Diagrama de flujo



Certificado

LGA_38418.

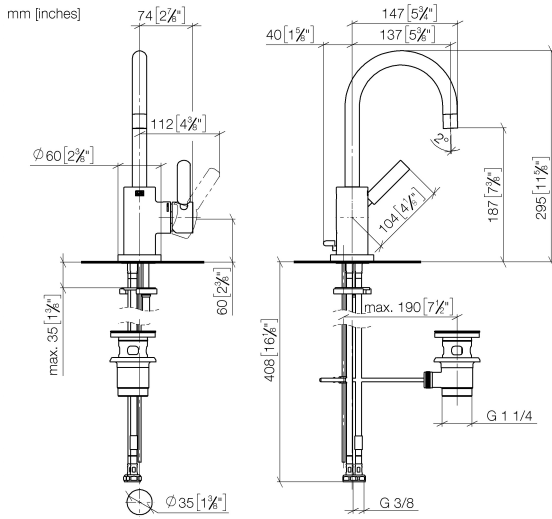
WRAS_2212025.

33 500 882

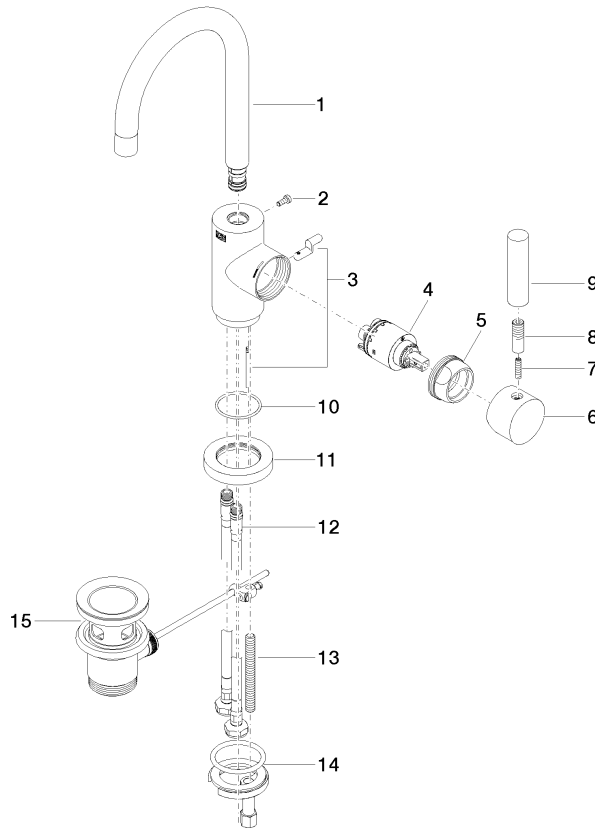

Lista de piezas de recambios

N°	Número de artículo	Denominación	Cantidad de montaje	Plazo de entrega
1	90 28 22 371 00-00	caño	1	10
2	09 30 30 054 90	tornillo	1	2
3	04 20 16 031 80-00	varilla de tiro	1	10
4	90 15 05 065 00 90	cartucho	1	2
5	09 24 04 107-00	tuerca	1	10
6	90 20 88 040 00-00	manilla	1	10
7	09 31 11 010 90	varilla	1	2
8	90 24 04 048 00-00	boquilla	1	10
9	11 170 880-00	manilla	1	10
10	09 14 10 034 90	sello	1	2
11	09 28 10 055-00	roseta	1	10
12	04 30 04 104 00 90	manguera	2	2
13	09 31 11 011 90	varilla	1	2
14	04 30 11 038 00 90	juego de fijación	1	2
15	90 11 01 001 00-00	juego de evacuación	1	10